



SUBARU

PART NUMBER: E361SXA400

DESCRIPTION: CROSSBAR KIT

**INSTALLATION
INSTRUCTIONS**

FOR TRIBECA ROOF RAILS

A KIT CONTENTS:

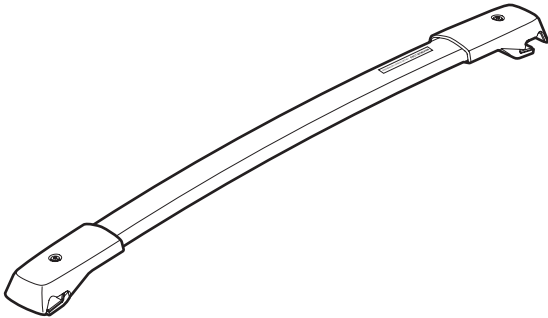

Front Crossbar Assembly 1x

B

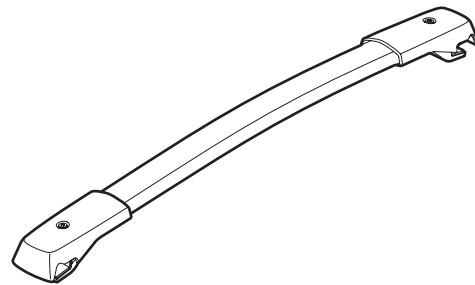

Rear Crossbar Assembly 1x

C

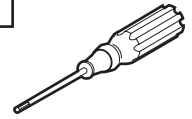

Torx Head
Screw Driver 1x

D

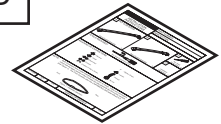

Installation
Instructions 1x

TOOLS REQUIRED

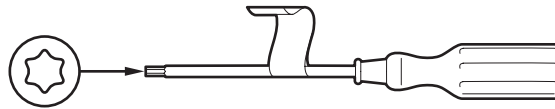

Torx Head Screwdriver (T-30)

MEANING OF CHARACTERS:

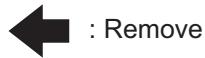

: Remove

T : Tighten Torque

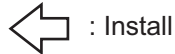

: Install

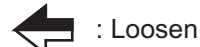

: Loosen



: Disconnect



: Discard



: Connect



: Re use

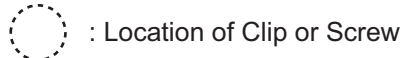

: Location of Clip or Screw

NOTE: Both Crossbars have a label indicating the direction of mount. If they are not present, orient with the larger section of the Crossbar towards the front of vehicle (see Figure 1). The Front Crossbar has a MAXIMUM LOAD label affixed to it.



Figure 1 - Crossbar (section)

PART NUMBER
E361SXA400

ISSUE
01

DATE
02/12/07

SUBARU OF AMERICA

PAGE
1/2

1 Front Crossbar

MAXIMUM LOAD 150 LBS. EVENLY DISTRIBUTED

Note:
Front Crossbar has Load Sticker and is longer than the Rear Crossbar.

2 Front Crossbar

3 Front Crossbar

Torque:
30-35 in./lbs

Front of Vehicle

4 Front Crossbar

12"
(300 mm)

Front of Vehicle

5 Rear Crossbar

Note:
Rear Crossbar is shorter than the Front Crossbar.

6 Rear Crossbar

7 Rear Crossbar

Torque:
30-35 in./lbs

Front of Vehicle

8 Rear Crossbar

2"
(50 mm)

Front of Vehicle